



SmartGen
ideas for power

HSM300 SYNCHRONOUS MODULE USER MANUAL



SMARTGEN (ZHENGZHOU) TECHNOLOGY CO.,LTD.



Chinese trademark

SmartGen English trademark

SmartGen — make your generator *smart*

SmartGen Technology Co., Ltd.

No.28 Jinsuo Road

Zhengzhou

Henan Province

P. R. China

Tel: 0086-371-67988888/67981888

0086-371-67991553/67992951

0086-371-67981000(overseas)

Fax: 0086-371-67992952

Web: www.smartgen.com.cn

www.smartgen.cn

Email: sales@smartgen.cn

All rights reserved. No part of this publication may be reproduced in any material form (including photocopying or storing in any medium by electronic means or other) without the written permission of the copyright holder.

Applications for the copyright holder's written permission to reproduce any part of this publication should be addressed to SmartGen Technology at the address above.



Any reference to trademarked product names used within this publication is owned by their respective companies.

SmartGen Technology reserves the right to change the contents of this document without prior notice.

Table 1 - Software Version

Date	Version	Content
2015-05-21	1.0	Original release.
2017-03-09	1.1	Add description of Raise/Drop Speed Relay Output Control; Modified parameters' default values of Rated Voltage, Under Frequency and etc.
2018-08-21	1.2	"Widely power supply range DC(8~35)V, suitable to different starting battery voltage environment" changed as "Widely power supply range DC(8~35)V" in section 2.

Table 2 – Symbol Description

Sign	Instruction
 NOTE	Highlights an essential element of a procedure to ensure correctness.
 CAUTION!	Indicates a procedure or practice, which, if not strictly observed, could result in damage or destruction of equipment.

SmartGen

CONTENT

1	OVERVIEW	5
2	PERFORMANCE AND CHARACTERISTICS	5
3	SPECIFICATION.....	5
4	PANEL INDICATORS AND TERMINALS DESCRIPTION	6
5	SCOPES AND DEFINITIONS OF PROGRAMMABLE PARAMETERS	8
6	FUNCTION DESCRIPTION.....	9
7	RAISE/DROP SPEED RELAY OUTPUT CONTROL	10
8	TYPICAL DIAGRAM	11
9	CASE DIMENSION.....	12
10	INSTALLATION NOTES	12
10.1	OUTPUT AND EXPAND RELAYS	12
10.2	WITHSTAND VOLTAGE TEST	12

SmartGen

1 OVERVIEW

HSM300 Synchronous Module is special design for genset automatic parallel. On the basis of the parameters, the module automatically tests the conditions of paralleling (voltage difference, frequency difference and phase) and send parallel signal when the conditions meet parallel requirements.

HSM300 Synchronous Module is used for the occasions that gens synchronize to bus. The module is brief to operate, easy to install and widely used for ship genset and land genset.

2 PERFORMANCE AND CHARACTERISTICS

- Suitable for 3-phase 4-wire, 3-phase 3-wire, 2-phase 3-wire, single phase 2-wire systems with frequency 50/60/Hz;
- Adjustable potentiometer allows for set main parameters of synchronizing;
- The operating parameters can be set via upper computer test software. LINK port should be connected to upper computer via SG72 module (USB to LINK);
- 4 relays output, 2 relays are used for UP output, DOWN output, 1 SYNC relay is used for sync close output, 1 STATUS relay is used for status output after close;
- 1 INH “inhibit sync close output” digital input, when the input is active and gens synchronize with bus, the SYNC indicator will illuminate and sync close relay is inhibited to output;
- Widely power supply range DC(8~35)V;
- 35mm guide rail mounting;
- Modular design, pluggable terminal, compact structure with easy installation.

3 SPECIFICATION

Table 3 – Product Parameters

Parameter	Details
Working Voltage	DC8.0V to 35.0V, continuous power supply.
Overall Consumption	≤1W(Standby mode≤0.5W)
AC Input	AC50V~ AC620 V (ph-ph)
AC Frequency	50Hz/60Hz
SYNC Output	7A AC250V Volts free output
UP Output	5A AC250V/5A DC30V Volts free output
DOWN Output	5A AC250V/5A DC30V Volts free output
STATUS Output	5A AC250V/5A DC30V Volts free output
Case Dimensions	71.6mm x 89.7mm x 60.7mm
Working Conditions	Temperature: (-25~+70)°C Humidity: (20~95)%
Storage Conditions	Temperature: (-25~+70)°C
Insulation Intensity	Apply AC2.2kV voltage between high voltage terminal and low voltage terminal; The leakage current is not more than 3mA within 1min.
Weight	0.20kg

4 PANEL INDICATORS AND TERMINALS DESCRIPTION

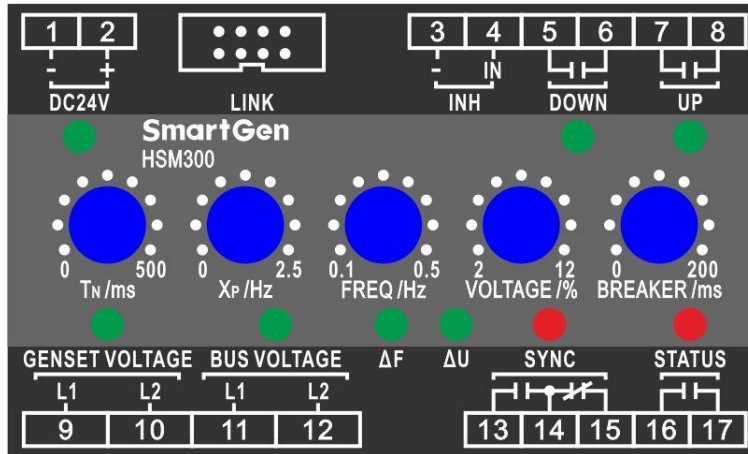

Fig.1 - Mask Drawing

Table 4 - LEDs Definition Description

Indicators	Color	Description	Notes
DC 24V	Green	Power indicator, the lamp illuminate when the power works well.	
UP	Green	When the raising speed pulse is sent, the lamp will illuminate.	
DOWN	Green	When the decreasing speed pulse is sent, the lamp will illuminate.	
GENSET	Green	When gens voltage and frequency normally, the lamp will illuminate; when gens voltage and frequency abnormally, the lamp will glitter; when there is no power, the lamp will extinguish.	
BUS	Green	When bus voltage and frequency normally, the lamp will illuminate; when bus voltage and frequency abnormally, the lamp will glitter; when there is no power, the lamp will extinguish.	
ΔF Freq Difference	Green	When gens and bus voltage, frequency normally, and real time frequency difference is within the setting limits, the lamp will illuminate.	
ΔU Volt Diff.	Green	When gens and bus voltage, frequency normally, and real time voltage difference is within the setting limits, the lamp will illuminate.	
SYNC Close	Red	When close relay outputs, the lamp will illuminate. Close pulse: 400ms.	
STATUS	Red	After close signal output, the relay output and the lamp will illuminate; when gens not synchronize with bus is detected, the relay will not output and the lamp will extinguish.	

Table 5 - Potentiometer Description

Potentiometer	Range	Description	Note
TN/ms control length of pulse	(25-500)ms	Control min. last time of pulse.	
Xp/Hz proportion range	(0 \pm 2.5)Hz	In this area, pulse width and deviation value of rated frequency are in direct proportion.	Xp/Hz proportion range
FREQ/Hz	(0.1-0.5)Hz	Acceptable frequency difference.	
VOLTAGE/%	(2-12)%	Acceptable Voltage difference	
BREAKER/ms	(20-200)ms	The time of switch close.	

Table 6 - Terminal Description

No.	Function	Cable	Note	
1.	DC 24V -	1.0mm ²	Connected with negative of starter battery.	
2.	DC 24V +	1.0mm ²	Connected with positive of starter battery.	
3.	INH	-	"Close Output Inhibit" Input	
4.		IN		
5.	DOWN Output	2.5mm ²	Output when speed reduces.	Normally open, close; Volts free output; 5A Rated
6.				
7.	UP Output	2.5mm ²	Output when speed raise.	Normally open, close; Volts free output; 5A Rated
8.				
9.	GEN L1	1.0mm ²	Gen AC voltage input.	
10.	GEN L2			
11.	BUS L1	1.0mm ²	Bus AC voltage input.	
12.	BUS L2			
13.	SYNC	Normally Open	Output when SYNC close.	Normally open, normally close; Volts free output; 7A Rated
14.		COM		
15.		Normally Close		
16.	STATUS	1.0mm	Output when close.	Normally open, Volts free output; 5A Rated
17.		1.0mm		
LINK	Used for parameters setting or software upgrade.			



Fig.2 – PC Programming Connection

Note: Parameters setting and real-time monitoring can be implemented via LINK port by using PC software and an SG72 adapter which produced by our company.

5 SCOPES AND DEFINITIONS OF PROGRAMMABLE PARAMETERS

Table 7 – Module Configurable Parameters

No.	Items	Parameters	Defaults	Description
1.	AC System	(0-3)	0	0: 3P3W, 1: 1P2W, 2: 3P4W, 3: 2P3W
2.	Rated Voltage	(30-30000) V	400	
3.	PT Fitted	(0-1)	0	0: Disabled 1: Enabled
4.	PT Primary	(30-30000)V	100	
5.	PT Secondary	(30-1000)V	100	
6.	Over Volt	(0-1)	1	0: Disabled 1: Enabled
7.		(100-120) %	115	Threshold
8.		(100-120) %	113	Returned
9.		(0-3600) s	3	Delay
10.	Under Volt	(0-1)	1	0: Disabled 1: Enabled
11.		(70-100) %	82	Threshold
12.		(70-100) %	84	Returned
13.		(0-3600) s	3	Delay
14.	Over Frequency	(0-1)	1	0: Disabled 1: Enabled
15.		(100-120) %	110	Threshold
16.		(100-120) %	104	Returned
17.		(0-3600) s	3	Delay
18.	Under Frequency	(0-1)	1	0: Disabled 1: Enabled
19.		(80-100) %	90	Threshold
20.		(80-100) %	96	Returned
21.		(0-3600) s	3	Delay
22.	Bus AC System	(0-3)	0	0: 3P3W, 1: 1P2W, 2: 3P4W, 3: 2P3W
23.	Bus Rated Voltage	(30-30000) V	400	
24.	Bus PT Fitted	(0-1)	0	0: Disabled 1: Enabled
25.	Bus PT Primary	(30-30000)V	100	
26.	Bus PT Secondary	(30-1000)V	100	
27.	Bus Over Voltage	(0-1)	1	0: Disabled 1: Enabled
28.		(100-120) %	115	Threshold
29.		(100-120) %	113	Returned
30.		(0-3600) s	3	Delay
31.	Bus Under Voltage	(0-1)	1	0: Disabled 1: Enabled
32.		(70-100) %	82	Threshold
33.		(70-100) %	84	Returned
34.		(0-3600) s	3	Delay
35.	Bus Over Frequency	(0-1)	1	0: Disabled 1: Enabled
36.		(100-120) %	110	Threshold
37.		(100-120) %	104	Returned
38.		(0-3600) s	3	Delay
39.	Bus Under Frequency	(0-1)	1	0: Disabled 1: Enabled
40.		(80-100) %	90	Threshold
41.		(80-100) %	96	Returned

No.	Items	Parameters	Defaults	Description
42.		(0-3600) s	3	Delay
43.	Address	(1-254)	1	
44.	T _p	(1-20)	10	Speed regular pulse period=T _p ×T _N

6 FUNCTION DESCRIPTION

HSM300 Synchronous Module is to synchronize generator to bus. When voltage difference, frequency difference and phase difference are within pre-set value, it will send synchronize signal to close gens switch. Because its switch close response time can be set, the module can be used for gensets of various source powers.

Thresholds of over voltage, under voltage, over frequency and under frequency of gens and bus can be set via monitoring software of PC. When the module detects voltage and frequency of gens and bus are normal, it will begin to adjust speed. When pressure difference, frequency difference and phase difference are within pre-set value, it will send synchronize signal to close gens switch.

SmartGen

7 RAISE/DROP SPEED RELAY OUTPUT CONTROL

When deviation area X_p is set as 2Hz, the working principle of raise/drop speed relay is as follows,

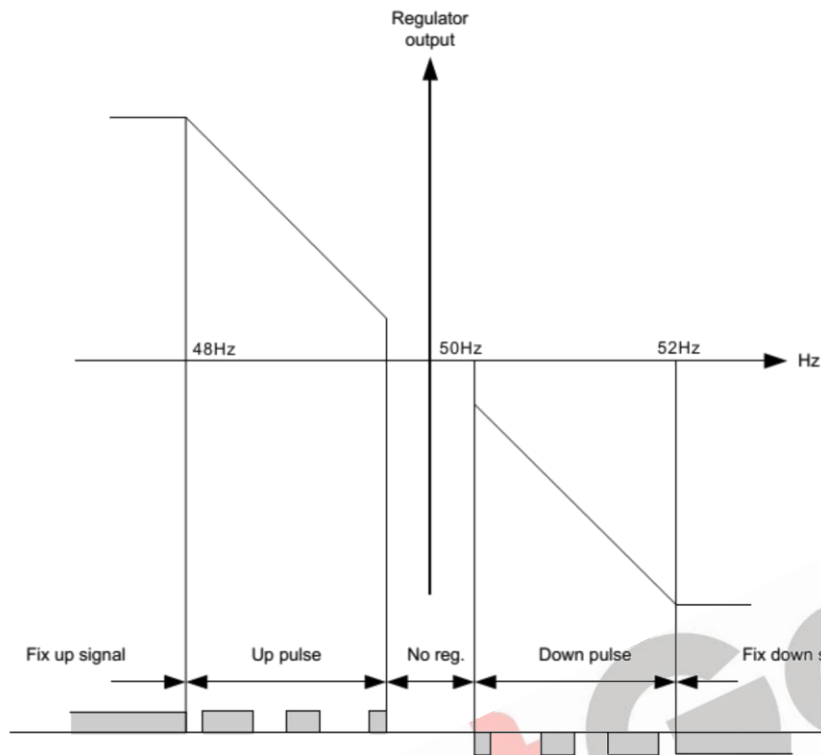

Fig.3 - working principle of raise/drop speed relay

Five steps for the relay to output regulatory function,

No.	Range	Description	Note
1	Fix Up Signal	Continuously raise signal	Activation adjusting. Since too large adjust error, ascending frequency relay will continuously be activated.
2	Up Pulse	Raise the pulse	System activates regulatory function, then ascending frequency relay will eliminate deviation in the pulse way.
3	No Reg.	No regulation	No regulation in this area.
4	Down pulse	Drop down the pulse	System activates regulatory function, descending frequency relay will eliminate deviation in the pulse way.
5	Fix down signal	Continuously drop down signal	System activates regulatory function, descending frequency relay will continuously be activated.

As showing in fig.3, when adjusting deviation X_p exceeds pre-set value, the relay will be in the continuous activate status; when X_p is not large, the relay will work in pulse way, and the pulse will become shorter along with the deviation became smaller. When regulator output value is close to “No Reg.”, pulse width will be the shortest value; when regulator output value is nearest to the “Down Pulse”, pulse width will be the longest value.

8 TYPICAL DIAGRAM

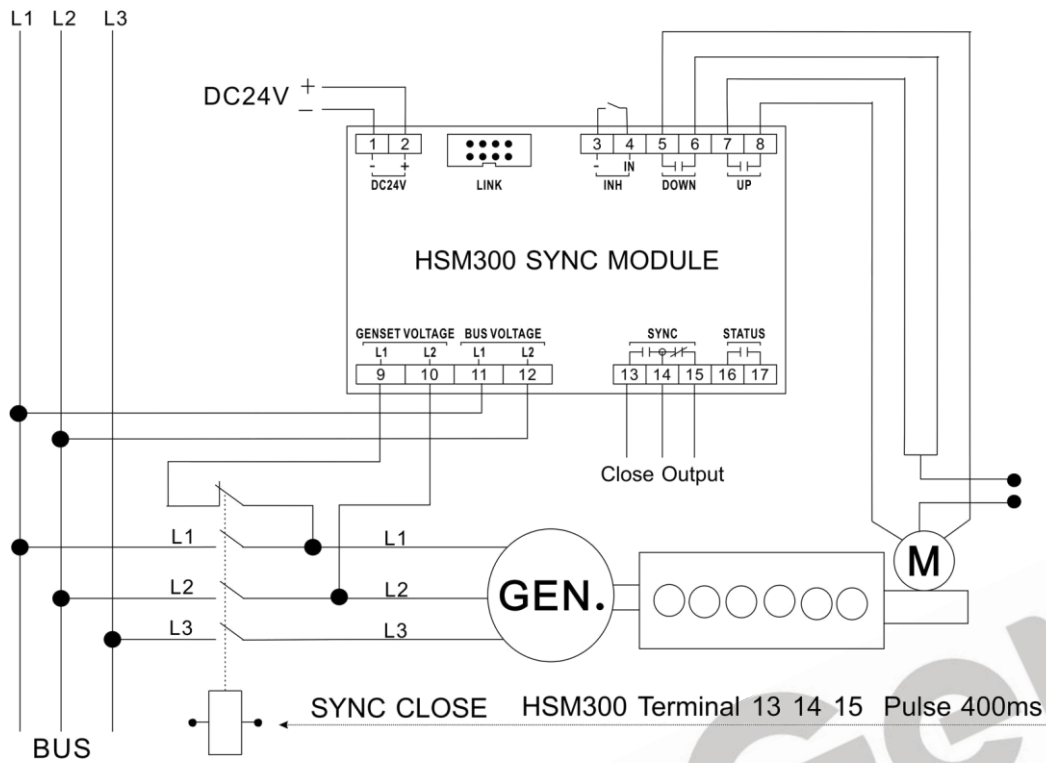

Fig. 4 - HSM300 3Phase 3Wire Typical Application

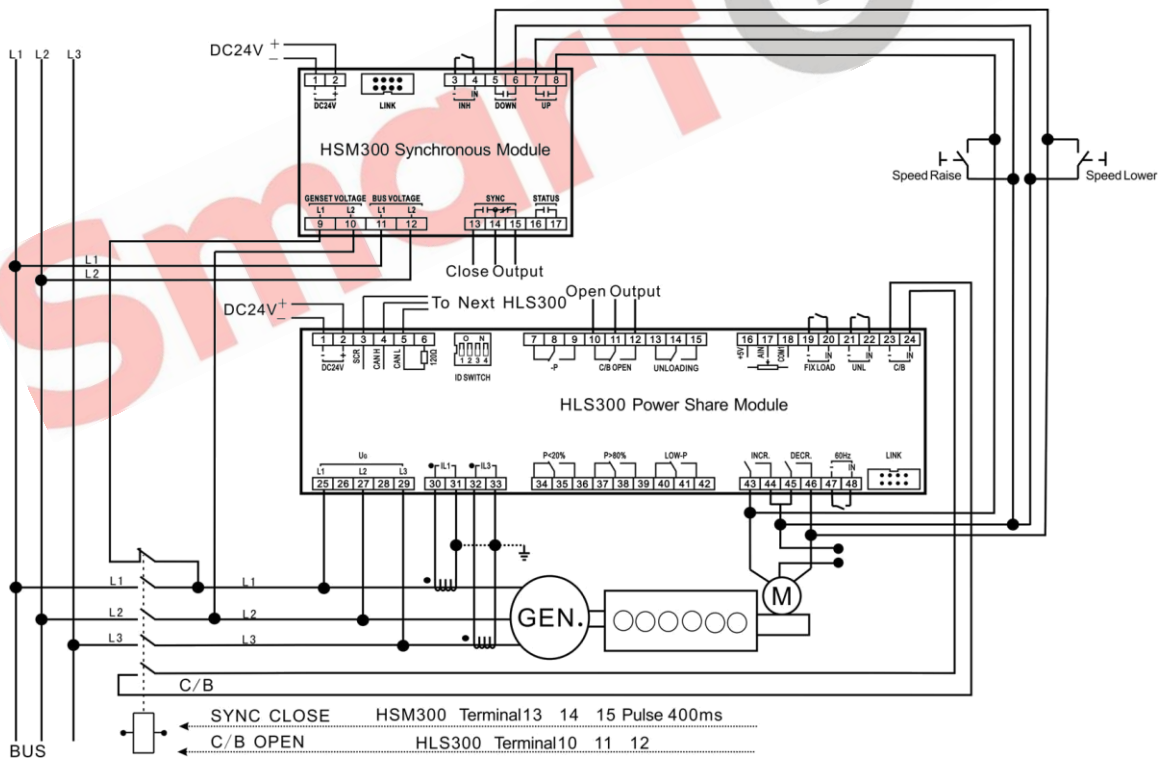

Fig.5 - HSM300-HLS300 3Phase 3Wire Typical Application

9 CASE DIMENSION

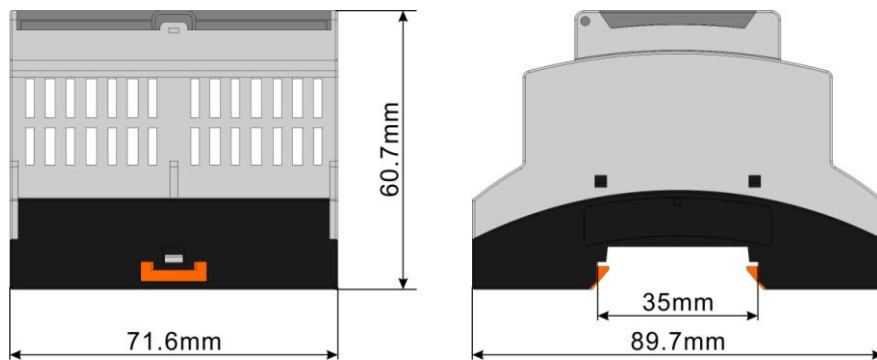

Fig.6 – Overall Dimensions

10 INSTALLATION NOTES

10.1 OUTPUT AND EXPAND RELAYS

All outputs are relay contact output type. If need to expand the relays, please add freewheel diode to both ends of expand relay's coils (when coils of relay has DC current) or, add resistance-capacitance return circuit (when coils of relay has AC current), in order to prevent disturbance to controller or others equipment

10.2 WITHSTAND VOLTAGE TEST

⚠ CAUTION! When relay had been installed in control panel, if need the high voltage test, please disconnect relay's all terminal connections, in order to prevent high voltage into relay and damage it.