

# Smartgen®

## ATS CONTROL PANEL SELECTION INSTRUCTION



Smartgen Technology



众智电子 Chinese trademark

**Smartgen**<sup>®</sup> English trademark

**Smartgen** — make your generator *smart*

**Smartgen Technology Co., Ltd.**

**No.28 Jinsuo Road**

**Zhengzhou City**

**Henan Province**

**P. R. China**

**Tel:** 0086-371-67988888/67981888

0086-371-67991553/67992951

0086-371-67981000(overseas)

**Fax:** 0086-371-67992952

**Web:** <http://www.smartgen.com.cn>

<http://www.smartgen.cn>

**Email:** sales@smartgen.cn

All rights reserved. No part of this publication may be reproduced in any material form (include photocopying or storing in any medium by electronic means or other) without the written permission of the copyright holder.

Applications for the copyright holder's written permission to reproduce any part of this publication should be addressed to Smartgen Technology at the address above.

Any reference to trademarked product names used within this publication is owned by their respective companies.

Smartgen Technology reserves the right to change the contents of this document without prior notice.

If there are any differences between the contents of the instruction and the product, please regard the actual product as the truth.

#### Version history

Date	Version	Note
2012-11-11	1.0	Original release
2012-12-7	1.1	Add wiring diagram introductions; Modify the installation dimension.

## Contents





<b>1</b>	<b>OVERVIEW.....</b>	<b>4</b>
<b>2</b>	<b>APPEARANCE AND CLASSIFICATION .....</b>	<b>4</b>
<b>3</b>	<b>BASIC TECHNICAL PARAMETERS .....</b>	<b>5</b>
<b>4</b>	<b>THEORY AND APPLICATION.....</b>	<b>6</b>
<b>4.1</b>	<b>2-WAYS MAINS (GIRD) AUTOMATIC CHANGE-OVER.....</b>	<b>6</b>
<b>4.2</b>	<b>1-WAY MAINS (GIRD) AND 1-WAY GENSET (GENERATOR) AUTOMATIC CHANGEVER .....</b>	<b>7</b>
<b>4.3</b>	<b>2-WAYS GENSETS (GENERATOR) AUTOMATIC CHANGEVER.....</b>	<b>8</b>
<b>5</b>	<b>CONTROL MODULE'S PARAMETER LIST .....</b>	<b>9</b>
<b>6</b>	<b>AUTOMATIC TRANSFER SWITCH PARAMETER LIST.....</b>	<b>10</b>
<b>6.1</b>	<b>63A ATS (N TYPE) .....</b>	<b>10</b>
<b>6.2</b>	<b>125A (N TYPE).....</b>	<b>10</b>
<b>6.3</b>	<b>160A/200A/250A (T TYPE) .....</b>	<b>11</b>
<b>6.4</b>	<b>400A (T TYPE) .....</b>	<b>11</b>
<b>6.5</b>	<b>630A (T TYPE) .....</b>	<b>12</b>
<b>6.6</b>	<b>630A/800A/1000A/1250A (M TYPE).....</b>	<b>12</b>

## 1 OVERVIEW

Two ways power ATS (Automatic Transfer Switch) Control Panel is used for two ways power change-over with load. The two ways power could be 2-way Mains (Grid), 1-way Mains with 1-way Gens (generator), or 2-way Gens. The panel's appearance structure will remain same under the same power capacity. For different power capacity's panel, the working theories are same but case dimensions are difference. Control capacity's range is from 63A to 1250A (corresponding capacity under three phase is from 35kW to 700kW).

Each control panel is equipped with Smartgen Controller as main control unit, as well as other accessories are all come from famous company. The box adopts metal body; deals with electrostatic coating process, fully efficient for using under different environmental conditions. It is reliable and cost-effective with simple connection and easy operation. Control panel can also be customized according to the user's requirements.

## 2 APPEARANCE AND CLASSIFICATION

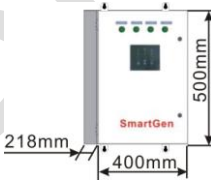
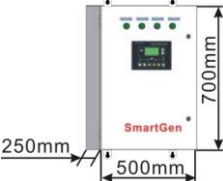
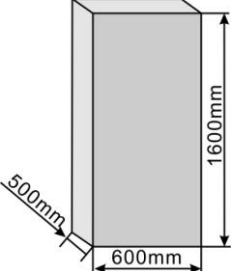
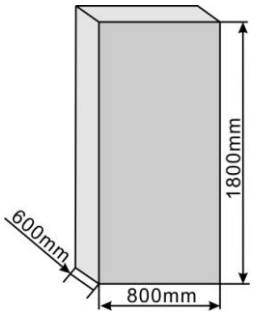
Current (Power)	63A~125A (35kW~70kW)	125A~400A (70kW~220kW)	400A~630A (220~350kW)	630A~1250A (220kW~700kW)
Appearance				
Installation way	Wall-mounted	Wall-mounted	Vertical	Vertical
Overall Size(mm)				
Installation Size(mm)	534X260 (height*length)	734X365 (height*length)	440X410 (length*width)	640X490 (length*width)
Installation Apertures(mm)	4xø8	4xø8	4xø10	4xø10
Outlet connection position	Bottom	Bottom	Bottom and back	Bottom and back

Weight (not include ATS & cooper bars )	Approx. 25kg	Approx. 30kg	Approx. 80kg	Approx.100kg
---	--------------	--------------	--------------	--------------

### 3 BASIC TECHNICAL PARAMETERS

Parameters	Contents
Working voltage range	(176~265)VAC
DC power voltage	(8~35)V(not necessary)
Body	Metal electrostatic coating, off-white
ATS Type	SMARTGEN SGQ series
Transfer time	Min. 3 Sec.
Control model	HAT220A, HAT600 series
Communication interface	RS485 Modbus-RTU (HAT600 only)
Language	Chinese /English (HAT600 only)
Installation way	Wall-mounted and vertical
Ambient	(-25~+70)°C
Humidity	(20~90)%
Elevation	≤5000 M
Safety requirements	Object: among Input/output/Power Test method: AC1.5KV/1min; Leakage current 3.5mA

## 4 THEORY AND APPLICATION

### 4.1. 2-WAYS MAINS (GIRD) AUTOMATIC CHANGE-OVER

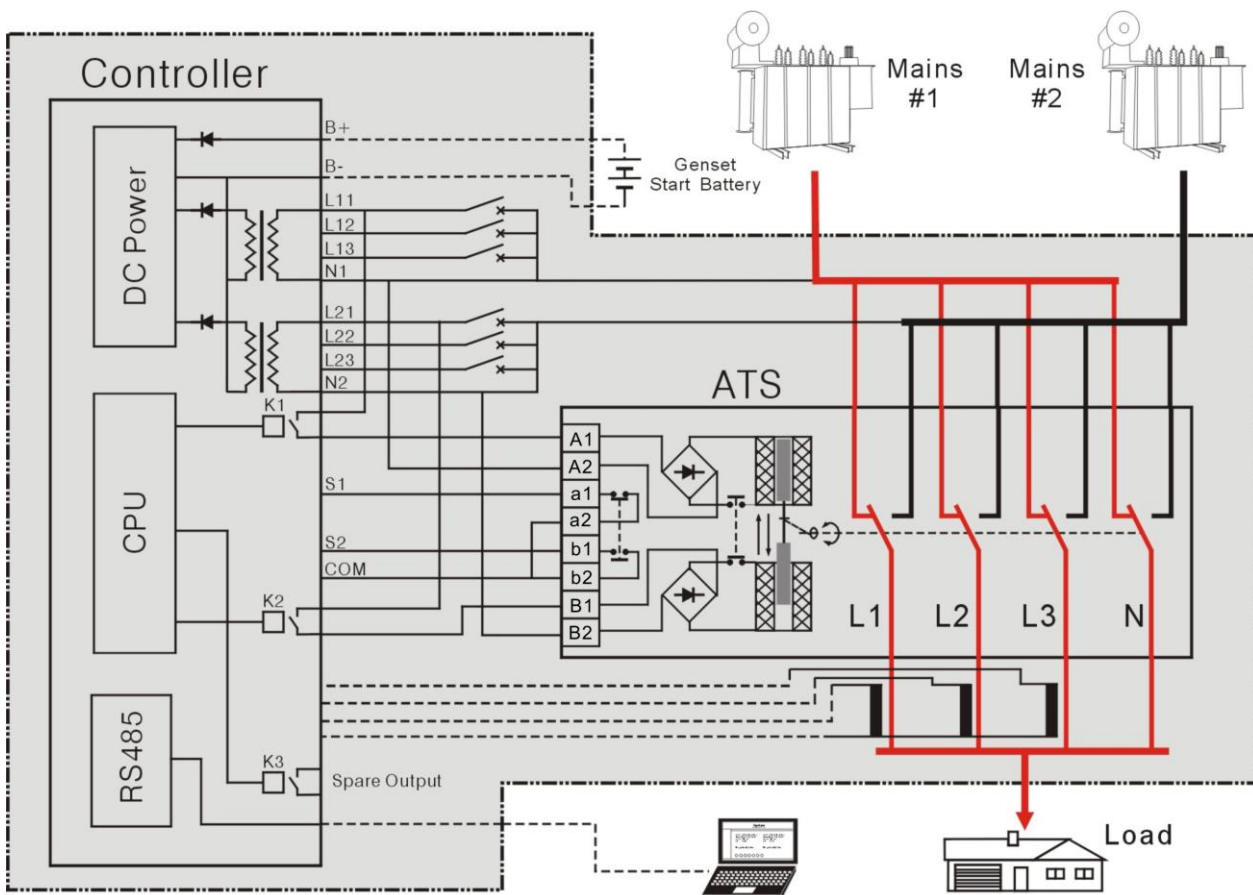

Note: The above drawing is suitable for N type and T type switch (SGQ), please refer to SGQ instruction for more details about M type switch.

Application Situation	Module Selection	Remarks
Only need basically automatic changeover function.	HAT220A	LED display
DC power supply and no necessary to detect power/current status.	HAT600	LCD display; Voltage abnormal signal output in both 2-way
No necessary to detect power/current status.	HAT600B	
DC power supply and need to detect power/current status.	HAT600I	
Need to detect power/current status.	HAT600BI	

Note: HAT600 series has RS485 standard communication interface. When need to communicate uninterruptedly, the control module MUST requires DC power supply.

## 4.2. 1-WAY MAINS (GIRD) AND 1-WAY GENSET (GENERATOR) AUTOMATIC CHANGEOVER

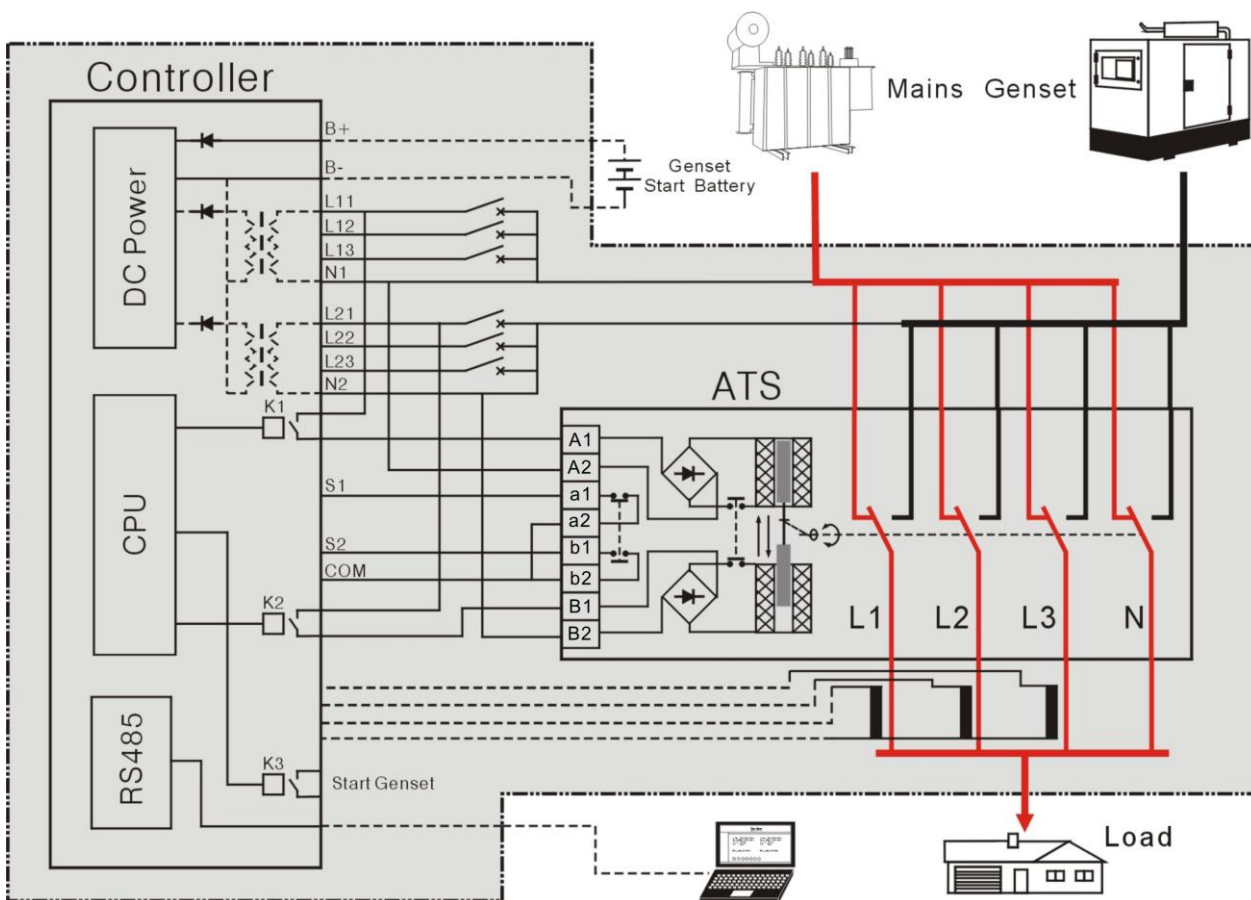

Note: The above drawing is suitable for N type and T type switch (SGQ), please refer to SGQ instruction for more details about M type switch.

Application Situation	Module Selection	Remarks
Only need basically automatic changeover function.	HAT220A	LED display
DC power supply and no necessary to detect power/current status.	HAT600	LCD display; Timing commissioning
No necessary to detect power/current status.	HAT600B	
DC power supply and need to detect power/current status.	HAT600I	
Need to detect power/current status.	HAT600BI	

Note:  
 1. Both HAT220A and HAT600 series can start Genset automatically when Mains is failed.  
 2. HAT600 series has RS485 standard communication interface. When need to communicate uninterruptedly, the control module MUST requires DC supply.

### 4.3. 2-WAYS GENSETS (GENERATOR) AUTOMATIC CHANGEOVER

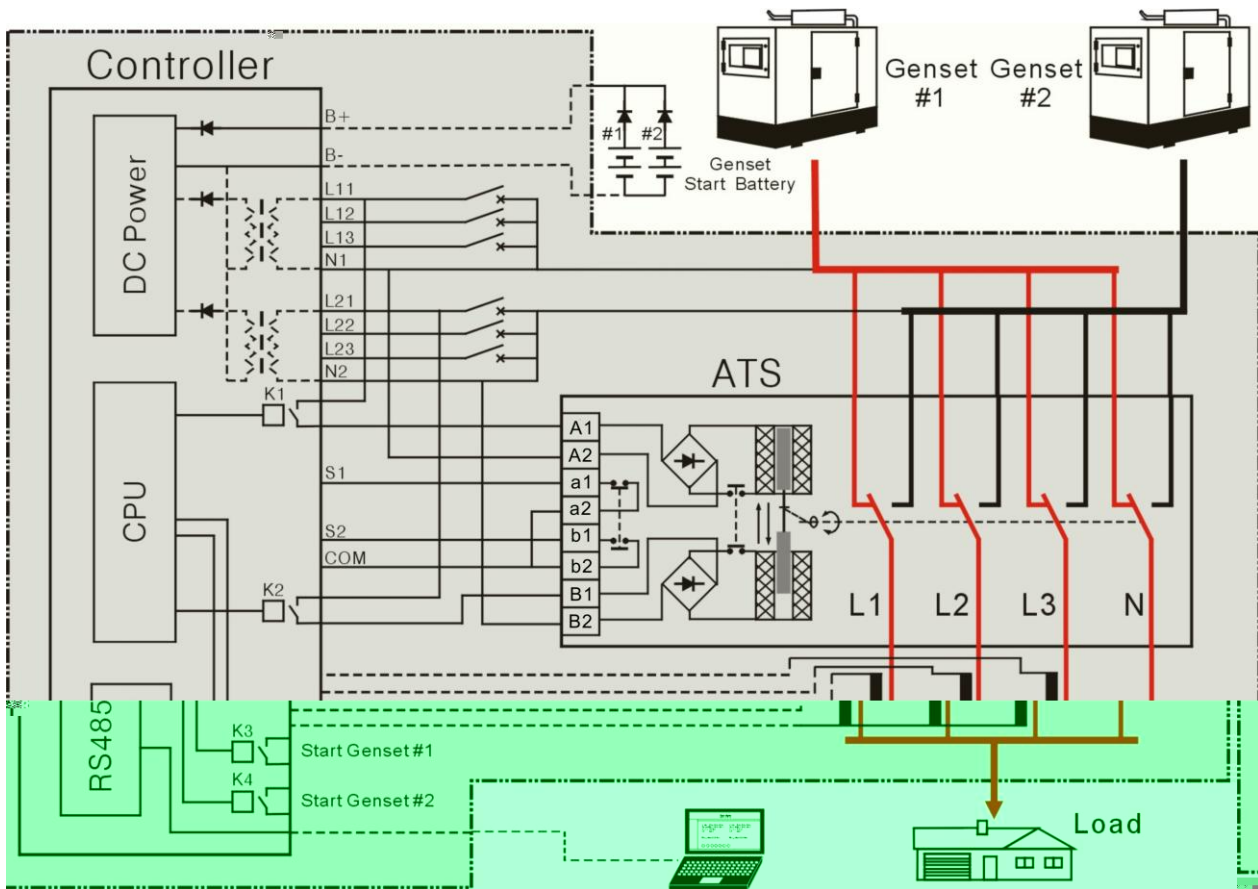



Note: The above drawing is suitable for N type and T type switch (SGQ), please refer to SGQ instruction for more details about M type switch.

Application Situation	Module Selection	Remarks
Only need basically automatic changeover function.	HAT220A	LED display
DC power supply and no necessary to detect power/current status.	HAT600	LCD display; Cyclic start the Genset.
No necessary to detect power/current status.	HAT600B	
DC power supply and need to detect power/current status.	HAT600I	
Need to detect power/current status.	HAT600BI	

Note: HAT600 series has RS485 standard communication interface. When need to communicate uninterruptedly, the control module MUST requires DC supply.





## 5 CONTROL MODULE'S PARAMETER LIST



Items	HAT220A	HAT600	HAT600B	HAT600I	HAT600BI
Appearance					
DC power range	8V~35V DC				
Nominal AC voltage input range	160V~300V	50V~360V (phase-N)	50V~280V (phase-N)	50V~360V (phase-N)	50V~280V (phase-N)
AC sensing system	1P-2Wire, 3P-4Wire	1P-2Wire 2P-3Wire 3P-3Wire 3P-4Wire	1P-2Wire 2P-3Wire 3P-4Wire	1P-2Wire 2P-3Wire 3P-3Wire 3P-4Wire	1P-2Wire 2P-3Wire 3P-4Wire
Rated frequency	50/60Hz				
LED indicators	Yes				
Auto start genset when mains failed.	Yes				
Voltage detecting protection	Over or under voltage, No power	Over or under voltage, lost phase, anti-phase, over or under frequency			
Current detecting protection	No	No	3 phase current, active power, apparent power, power factor, over current protect		
Fault alarm	No	Yes			
Communication	No	Standard RS485, Modbus-RTU communication protocol			
Configurable digital input	No	4			
Configurable relay output	No	5			
Real Time Clock	No	Yes			
Commissioning	No	Yes			
Schedule start genset	No	Yes			
Cyclic starting of one of two Gensets	No	Yes			
Overall size (mm)	138x119x66	209x153x55			
Cutout (mm)	130x111	186x141			

## 6 AUTOMATIC TRANSFER SWITCH PARAMETER LIST



### 6.1. 63A ATS (N TYPE)

Item	2P	3P	4P
Appearance			
Weight	4kg	4.5kg	4.7kg
Overall size(mm)	172x186x155	200x186x155	228x186x155
Width of outlet cooper bar	12mm		
Aperture of bar	Ø5mm		

### 6.2. 125A (N TYPE)

Item	2P	3P	4P
Appearance			
Weight	4.5kg	5kg	5.65kg
Overall size(mm)	193x186x155	228x186x155	265x186x155
Width of outlet cooper bar	20mm		
Aperture of bar	Ø7mm		



**6.3. 160A/200A/250A (T TYPE)**

Item	3P	4P
Appearance		
Weight	16.5kg	18.5kg
Overall size(mm)	326x292x150	375x292x150
Width of outlet cooper bar	20mm	
Aperture of bar	Ø9mm	



**6.4. 400A (T TYPE)**

Item	3P	4P
Appearance		
Weight	18kg	20kg
Overall size(mm)	355x292x150	406x292x150
Width of outlet cooper bar	L line: 30mm N line: 20mm	
Aperture of bar	L line: Ø11mm N line: Ø 9mm	

**6.5. 630A (T TYPE)**

Item	3P	4P
Appearance		
Weight	20kg	22kg
Overall size(mm)	364x310x150	424x310x150
Width of outlet cooper bar	L line: 40mm N line: 30mm	
Aperture of bar	L line: Ø15mm N line: Ø15mm	

**6.6. 630A/800A/1000A/1250A (M TYPE)**

Item		3P	4P
Appearance			
Overall size(mm)		510x260x340	600x260x340
Weight	630A	42.3kg	49.7 kg
	800A	45.3 kg	54.4 kg
	1000A	48.3 kg	59.4 kg
	1250A	51.3 kg	64.5 kg
Width of outlet cooper bar	630A	30mm	
	800A	40mm	
	1000A	45mm	
	1250A	55mm	
Aperture of bar	630A	Ø12mm	
	800A	Ø15mm	
	1000A	Ø15mm	
	1250A	Ø15mm	